

bosal :aftermarket

Universal parts catalogue



Latest information on
www.catalogue.bosal.com

© Bosal-2021

Reproduction of the contents of this catalogue, in whole or in part, including numbers and illustrations, without the express permission of Bosal is prohibited. Every effort has been made to ensure that the information in this catalogue is correct, but Bosal cannot be held responsible for possible errors or omissions.

Content table

The Bosal universal M8 clamp.....	3	Pipe connectors.....	13
M8 universal.....	3	Insulator blocks.....	14
M10 universal.....	4	Exhaust cement.....	14
M10 for Audi and Volkswagen.....	4	Round tubes for exhaust systems.....	14
M8 for Mercedes, Fiat and Peugeot.....	4	Aluminised pipe extensions.....	14
M10 for Ford.....	5	Galvanised flexible tubes.....	15
M8 for Volvo and Renault.....	5	Universal catalytic converters for petrol engines.....	15
M8 for Citroën, Peugeot, Renault, Saab and Volvo.....	5	Universal oxygen sensors.....	15
Universal pipe hangers.....	5	Universal silencer line.....	16
Clamps.....	6	Hanging hook.....	17
Universal gaskets.....	6	Magnetic label.....	17
Washers/ Spring washers.....	6	Universal suspension brackets.....	17
Springs.....	7	PSA flanges.....	17
Spacer tubes.....	7	EOLYS® DPF additives range.....	18
Special bolts.....	8	Regeflex.....	18
Stud bolts.....	8		
Bolts.....	8		
Nuts.....	9		
Copper plated flange nuts.....	9		
Copper plated selflocking nuts.....	9		
Flexible pipe connectors.....	10		
Universal flexible pipe connectors with adjustable diameters.....	11		
Flexible pipe connectors soft flex.....	11		
Welding bends.....	12		
Pipe connectors.....	12		
Reducing bushes.....	13		

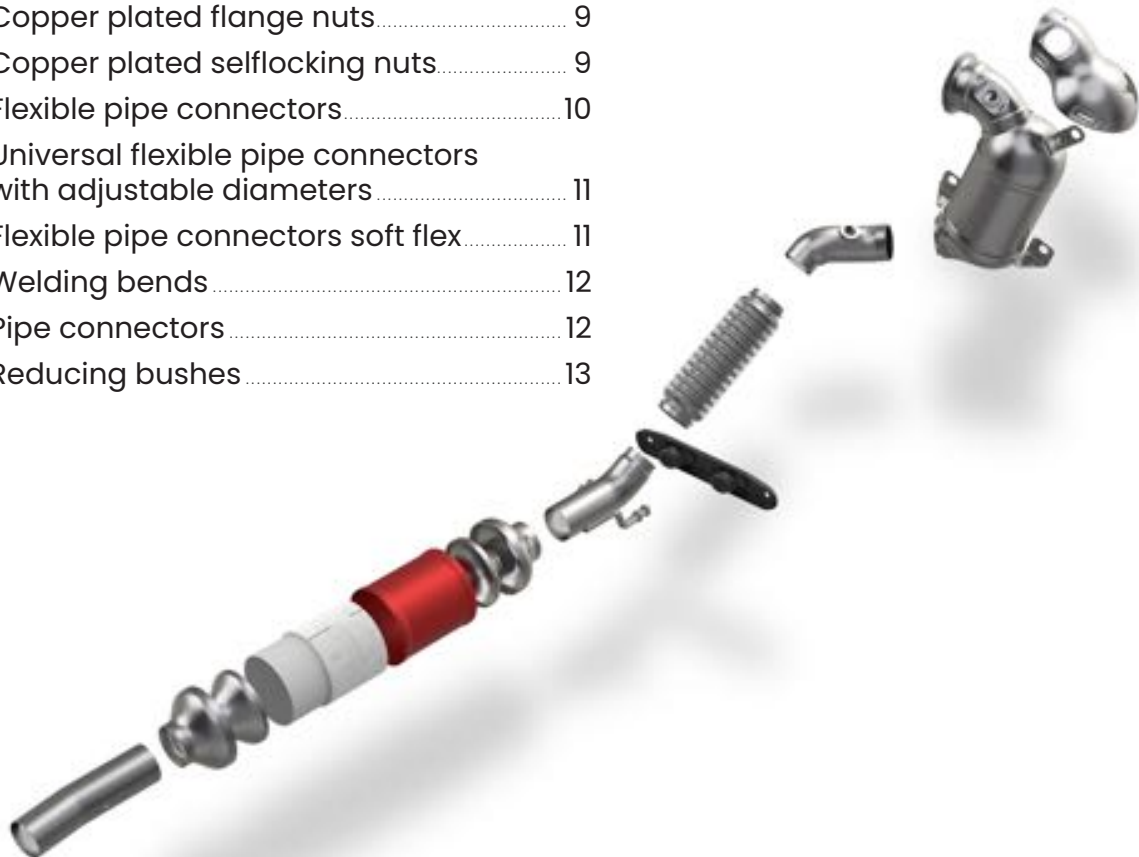

The Bosal universal M8 clamp



Rounded saddle

Bosal n°	Diameter (mm)	Packing quantity
250-236	36	10
250-238	38	10
250-938	38	100
250-240	40	10
250-940	40	100
250-242	42	10
250-942	42	100
250-245	45	10
250-945	45	100
250-248	48	10
250-948	48	100
250-250	50	10
250-950	50	100
250-252	52	10
250-952	52	100
250-254	54	10
250-954	54	100
250-258	58	10
250-958	58	100
250-260	60	10
250-265	65	10

The Bosal universal M8 clamp

Thanks to its specific bend-shape and deliberately inclined shoulders, the Bosal universal clamp has an even pressure distribution and therefore a perfect 100% gas tight fit.



M8 universal

Flat saddle

Bosal n°	Diameter (mm)	Packing quantity
250-228	28	1
250-232	32	1
250-836	36	10
250-838	38	10
250-840	40	10
250-842	42	10
250-845	45	10
250-848	48	10
250-850	50	10
250-852	52	10
250-854	54	10
250-856	56	10
250-858	58	10
250-860	60	10
250-864	64	10
250-275	75	1
250-283	83	1
250-289	89	1
250-299	100	1



M10 universal

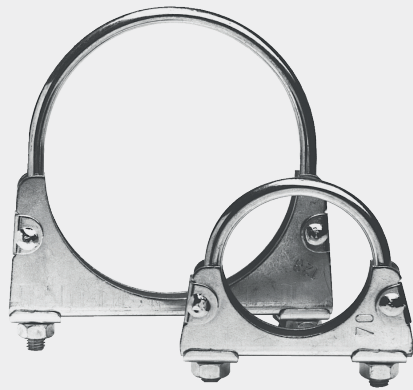

Flat saddle

Bosal n°	Diameter (mm)	Packing quantity
250-038	38	1
250-040	40	1
250-042	42	1
250-045	45	1
250-048	48	1
250-050	50	1
250-053	53	1
250-055	55	1
250-058	58	1
250-060	60	1
250-070	70	1
250-076	76	1
250-080	80	1
250-085	85	1
250-090	90	1
250-095	95	1
250-100	100	1
250-105	105	1
250-110	110	1
250-115	115	1
250-120	120	1
250-125	125	1
250-128	128	1
250-130	130	1
250-134	134	1
250-161	160	1



M10 for Audi and Volkswagen

Bosal n°	Diameter (mm)	Packing quantity
250-338	38,5	1
250-341	41,5	1
250-342	42,5	1
250-345	45,5	1
250-346	46,7	1
250-348	48,5	1
250-350	49,5	1
250-351	51,5	1
250-352	52,3	1
250-353	53,5	1
250-354	54,5	1
250-356	55,5	1
250-358	58,5	1
250-360	59,5	1
250-362	62,5	1
250-365	64,5	1

M8 for Mercedes, Fiat and Peugeot

Bosal n°	Diameter (mm)	Packing quantity
250-438	38,5	1
250-442	42,5	1
250-445	45,5	1
250-448	48,5	1
250-451	51,5	1
250-453	53,5	1
250-454	54,5	1
250-458	58,5	1
250-461	61	1
250-465	65	1

M10 for Ford



Bosal n°	Diameter (mm)	Packing quantity
250-135	35	1
250-138	38	1
250-142	41	10
250-145	45	10
250-148	48	10
250-150	50	10
250-151	51	1
250-154	53	10
250-155	55	1
250-158	58	10
250-160	60	1
250-162	62	1
250-164	64	1

M8 for Citroën, Peugeot, Renault, Saab and Volvo

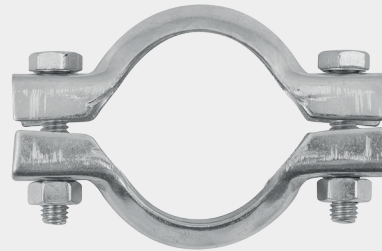

Bosal n°	Diameter (mm)	Packing quantity
254-121	47	1
254-371	49	1
254-375	53	1
254-627	58	1
254-920	66	1
254-355*	66	1
254-950	69	1
254-930	72	1
254-701	74	1
254-702	76	1
254-940*	79	1

* welded bolts

M8 for Volvo and Renault

Bosal n°	Diameter (mm)	Packing quantity
250-542	42	1
250-543	45	1
250-547	48	1
250-551	51	1
250-554	55	1
250-561	61	1
250-564	64	1



Universal pipe hangers



Bosal n°	Diameter (mm)	Packing quantity
250-525	25	1

Clamps



Bosal n°	Diameter (mm)	Packing quantity
250-645	45	1
250-648	48	1
250-649	50	1
250-654	54	1
250-655	52	1
250-658	58	1
250-661	60	1
250-665	65	1

Washers/ Spring washers

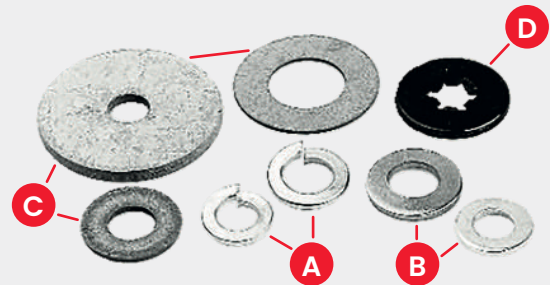

Bosal n°	Diameter (mm)	DIN	Model	Packing quantity
258-103	m8 x Ø 44 x 2		C	10
258-108	m8	DIN 127	A	10
258-110	m10	DIN 127	A	10
258-112	m12	DIN 127	A	10
258-113	m6 x Ø 18 x 1,4		B	10
258-117	m8 x Ø 17 x 1,5	DIN 125	B	10
258-118	Ø 8	Renault	D	10
258-120	Ø 10	Opel	D	10
258-121	m8 x Ø 21 x 4		B	10
258-126	Ø 32 x Ø 16 x 1		C	10
258-131	m10 x Ø 30 x 2,5		B	10
258-133	m10 x Ø 21 x 2	DIN 125	B	10
258-135	m12 x Ø 24 x 2,3	DIN 125	B	10
258-784	Ø 21 x Ø 10 x 3		C	10

Universal gaskets

Bosal n°	Length (mm)	Width (mm)	Diameter (mm)
256-035	95	65	35
256-038	100	70	38
256-042	105	75	42

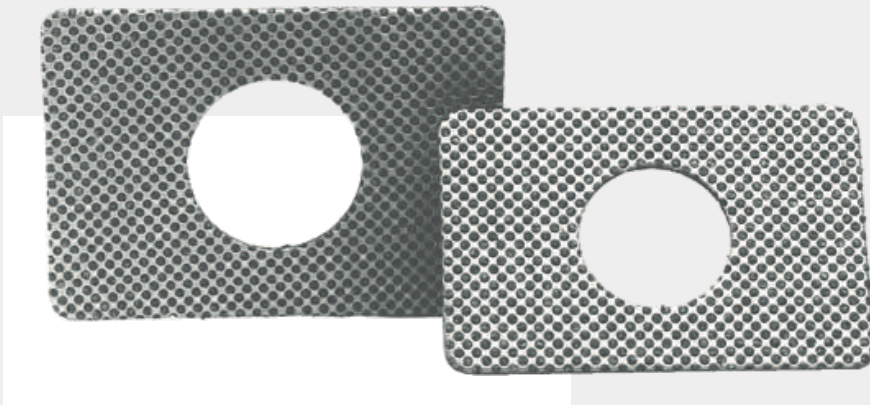

Springs

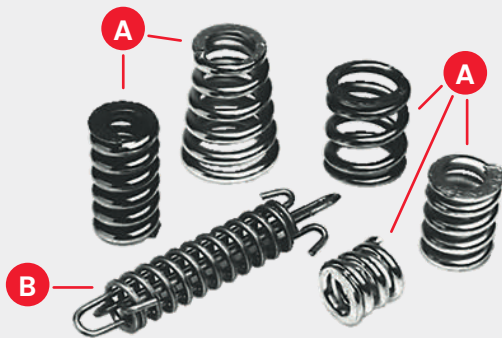

Bosal n°	Length (mm)	Model	Packing quantity
251-001	44	A	1
251-003	54	A	1
251-004	28	A	1
251-007	37	A	1
251-024	43	A	1
251-025	42	A	1
251-026	32	A	1
251-203	38	A	1
251-458	26	A	1
251-669	77	B	1
251-693	56	A	1
251-807	28	A	1
251-860	38	A	1
251-863	33	A	1
251-902	30	A	1
251-903	38	A	1
251-929	46	A	1
251-930	35	A	1
251-932	34	A	1
251-934	48	A	1
251-971	51	A	1

Dedicated mounting parts

BOSAL supports the emission control system, catalytic converter and DPF range with dedicated mounting parts. The perfect fit of a BOSAL product beneath the car is ensured by the right combination of product-specific mounting parts. More than 1.800 references are proof of this.



Spacer tubes



Bosal n°	Outside diameter (mm)	Inside diameter (mm)	Length (mm)	Packing quantity
258-930	12	8,5	48	1
258-960	12	8,5	25	1
258-964	12	8,5	37	1
258-966	12	8,5	22	1
258-931	12	8,5	32	1
258-932	12	8,5	43	1
258-933	12	8,5	58	1
258-934	11	8,5	72	1
258-940	15	10,5	50	1



Follow Bosal Aftermarket on LinkedIn

Want to stay informed about our extensive Aftermarket range and the team that makes it all happen?



[@company/bosal-aftermarket](https://www.linkedin.com/company/bosal-aftermarket)

Special bolts



Bosal n°	Diameter (mm)	Length (mm)	Application	Packing quantity
258-015	m6	58	Peugeot 205	1
258-022	m12	55	Hyundai	1
258-771	m6	53	Citroën/Peugeot	1
258-780	m7	80	Citroën/Peugeot	1
258-781	m6	46	Citroën/Peugeot	1
258-785	m6	42	Citroën/Peugeot	1
258-023	m6/m8	77	Citroën/Peugeot	1
258-786	m6	77	Peugeot	1
258-788	m8 x 1,25	108	Ford	1
258-789	m10	70	Ford L40	1
258-791	m6	57	Citroën/Peugeot	1
258-793	m7	67	Citroën/Peugeot	1
258-794	m8	63	Opel Vectra	1
258-986	m10 x 1,25	75	Mazda	1
258-726	m8	107	Renault	1
258-895	m10	73	Opel Kadett D-E/Corsa A	1
258-904	m10	57	Opel Corsa 1000 S	1
258-942	m10 x 1,25	52	Suzuki	1
258-943	m10 x 1,25	65	Suzuki	1
258-944	m8	60	Austin/Honda	1
258-974	m8	90	Renault	1

Stud bolts



Bosal n°	Diameter (mm)	Length (mm)	Packing quantity
258-946	m8	41	1
258-948	m8	35	10
258-949	m8	43	10
258-950	m8	45	10
258-947	m10 x 1,25	43	1
258-951	m10 x 1,25	37	10
258-953	m10	40	10
258-954	m10	47	10
258-955	m10	55	10
258-927	m12 x 1,25	50	10
258-956	5/16" UNF	42	1
258-959	3/8" UNC	41	1
258-987	m10 x 1,25	94	10

Bolts



Bosal n°	Diameter (mm)	Length (mm)	Packing quantity
258-616	m6	16	10
258-650	m6	50	10
258-660	m6	60	10
258-740	m7	40	10
258-816	m8	16	10
258-820	m8	20	10
258-825	m8	25	10
258-830	m8	30	10
258-835	m8	35	10
258-840	m8	40	10
258-845	m8	45	10
258-850	m8	50	10
258-855	m8	55	10
258-860	m8	60	10
258-865	m8	65	10
258-870	m8	70	10
258-880	m8	80	1
258-888	m8	90	1
258-889	m8	100	1
258-886	m10	20	1
258-893	m10 x 1,25	25	1
258-890	m10	30	1
258-887	m10 x 1,25	30	1
258-885	m10	35	1
258-907	m10 x 1,25	35	1
258-891	m10	40	1
258-906	m10 x 1,25	40	1
258-892	m10	50	1
258-883	m10	55	1
258-908	m10 x 1,25	60	1
258-896	m10	65	1
258-897	m10	70	1
258-899	m10	80	1
258-910	5/16 x 1" UNF		1
258-924	m12 x 1,25	35	1

Nuts



Bosal n°	Diameter (mm)	DIN/ANSI Cu: copper plated	Packing quantity
258-026	m6	DIN 980 V/8 Cu	10
258-036	m6	DIN 267 Cu	10
258-007	m7	DIN 934 V/8	10
258-008	m8	DIN 934	10
258-009	m8	DIN 936/H4	10
258-028	m8	DIN 980 V/9 Cu	10
258-038	m8	DIN 267 Cu	10
258-053	m8	MESSING	10
258-010	m10	DIN 934	10
258-040	m10	DIN 267 Cu	10
258-047	m10 x 1,25	DIN 267 Cu	10
258-052	m10 x 1,25	MESSING	10
258-056	m10 x 1,25	DIN 980 V/8 Cu	10
258-030	m10 x 1,5	DIN 980 V/8 Cu	10
258-050	m10 x 1,5 SW 14	DIN 980 V/8 Cu	10
258-055	m12 x 1,5	DIN 934	1
258-060	m12 x 1,25	DIN 934/8	10
258-016	5/16 UNF	ANSI B 18-2-2/8	10

Copper plated flange nuts



Bosal n°	Diameter (mm)	Packing quantity
258-336	m6	50 x 258-036
258-338	m8	50 x 258-038
258-340	m10	50 x 258-040
258-347	m10 x 1,25	50 x 258-047

Copper plated selflocking nuts



Bosal n°	Diameter (mm)	Packing quantity
258-326	m6	50 x 258-026
258-328	m8	50 x 258-028
258-330	m10	50 x 258-030
258-350	m10/SW14	50 x 258-050
258-356	m10 x 1,25	50 x 258-056

Bosal webcatalogue

Discover all Bosal Aftermarket products on our webcatalogue. Our webcatalogue is continuously updated and gives all the latest product information. Bosal products can be searched for by car type, Bosal number, OE number and Ktype number.

Besides our own webcatalogue, our products also are available in TecDoc, for which we are certified data supplier.

www.catalogue.bosal.com



Flexible pipe connectors



INNERBRAID with innerbraid inner liner



INTERLOCK with interlock inner liner



Bosal n°	Model	Inside diameter (mm)	Length flex (mm)	Length total (mm)
265-205*	B	25,5	155	155
265-713	A	42,0	269	383
265-307	B	45,0	153	153
265-309	B	45,0	200	200
265-311	B	45,0	230	230
265-313	B	45,0	260	260
265-701	A	45,0	158	272
265-703	A	45,0	208	322
265-705	A	45,0	269	383
265-305	B	45,5	102	102
265-565	B	46,0	190	190
725-387	A	48,0	206	408
265-319	A	49,0	180	200
265-315	B	50,0	95	95
265-321	B	50,0	230	230
265-325	B	50,0	282	282
265-719	A	50,0	208	322
265-721	A	50,0	269	383
265-317	B	51,0	150	150
265-707	A	51,5	156	270
265-331	B	54,0	200	200
265-727	A	54,0	158	272
739-137	A	54,0	200	345
265-329	B	55,0	150	150
265-333	B	55,0	220	220
265-335	B	55,0	250	250
265-337	B	55,0	280	280
265-327	B	56,5	101	101
265-339	B	63,0	203	203
265-341	B	63,0	252	252

* without inner liner

Bosal n°	Model	Inside diameter (mm)	Length flex (mm)	Length total (mm)
265-609	A	38,0	158	272
265-021	B	40,0	100	100
265-023	B	40,0	150	150
265-611	A	42,0	158	272
265-613	A	42,0	269	383
265-677	B	45,0	250	250
265-561	B	45,0	95	95
265-579	B	50,5	200	200
265-715	A	45,0	158	272
265-631	A	48,0	158	272
265-517	A	50,0	158	272
265-519	A	50,0	208	322
265-521	A	50,0	269	383
265-681	B	50,5	250	250
265-567	B	51,0	100	100
265-573	B	51,0	190	190
265-623	A	52,0	126	240
265-625	A	52,0	208	322
265-627	A	54,0	158	272
265-571	B	55,5	190	190
265-585	B	55,7	105	105
265-629	A	60,0	158	272
265-587	B	60,0	120	120

Universal flexible pipe connectors with adjustable diameters

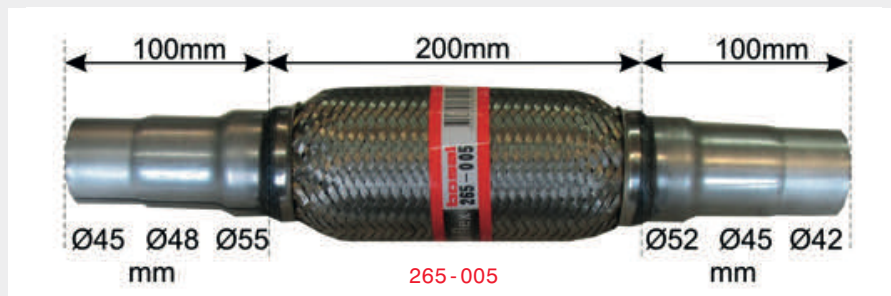

Bosal n°	Inside diameter (mm)	Inside diameter (mm)	Material thickness (mm)	Length flex (mm)	Length total (mm)
265-003	42/45/52	45/48/55	1,5	100	400
265-005	42/45/52	45/48/55	1,5	200	400

Flexible pipe connectors soft flex



Bosal n°	Inside diameter (mm)	Length flex (mm)
265-539	45	200
265-543	45	250
265-537	50	200
265-541	55	200
265-545	60	180

Extensive product range

Bosal is offering a wide range of AM products. In our aftermarket range we are offering silencers & pipes, catalytic converters, DPF's, kits & parts, towbars and e-sets and bicycle carriers. Besides this we also offer Eolys for PSA engines.

- **Silencers & pipes:** 3.500 refs
- **Catalytic converters:** 975 refs
- **DPF's:** 287 refs
- **Kits & parts:** 1.800 refs
- **Towbars & e-sets:** 1.099 refs
- **Bicycle carriers:** 3 refs

Extensive and continuous range expansion year by year.

Welding bends



Aluminised

Bosal n°	Outside diameter (mm)	Material thickness (mm)	Angle	Length (mm)
263-145	45	1,5	30°	255
263-148	48	1,5	30°	255
263-150	50	1,5	30°	255
263-154	54	1,5	30°	255
263-245	45	1,5	45°	285
263-248	48	1,5	45°	285
263-250	50	1,5	45°	285
263-254	54	1,5	45°	285
263-345	45	1,5	60°	310
263-348	48	1,5	60°	310
263-350	50	1,5	60°	310
263-354	54	1,5	60°	310
263-635	35	1,5	90°	260
263-638	38	1,5	90°	360
263-641	42	1,5	90°	360
263-445	45	1,5	90°	360
263-645	45	1,5	90°	360
263-448	48	1,5	90°	360
263-648	48	1,5	90°	400
263-450	50	1,5	90°	360
263-650	50	1,5	90°	400
263-454	54	1,5	90°	360
263-653	54	1,5	90°	500
263-657	57	1,5	90°	500
263-660	60	1,5	90°	590
263-665	65	2,0	90°	590
263-670	70	2,0	90°	590
263-675	76	2,0	90°	590
263-689	90	2,0	90°	590
263-700	102	2,0	90°	990
263-346	50	1,5	120°	400
263-249	54	1,5	120°	400
263-151	60	1,5	120°	400
263-255	50	1,5	135°	400
263-247	54	1,5	135°	400
263-147	60	1,5	135°	400
263-251	50	1,5	150°	400
263-155	54	1,5	150°	400
263-019	60	1,5	150°	400

Pipe connectors



Aluminised

Bosal n°	Inside diameter (mm)
265-935	35
265-938	38
265-941	42
265-945	45
265-948	48
265-950	50
265-953	54
265-957	57
265-960	60
265-963	65
265-970	70
265-975	76
265-980	80
265-989	89
265-999	102

Since there is no plan(et) B

Besides our continuous dedication to the Aftermarket business, Bosal is also looking at the future with our Microgrid & Energy division.

Discover more about this new exciting business on www.bosal.com

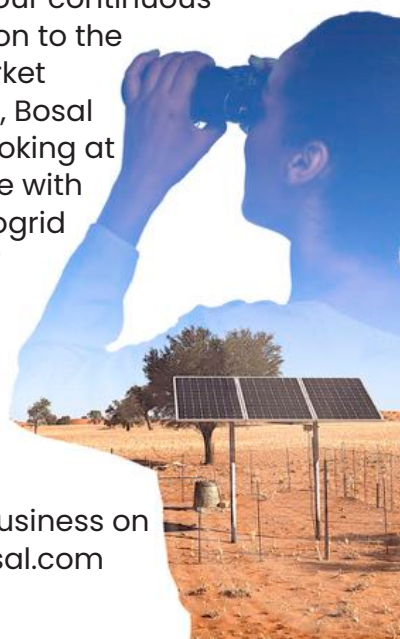

Reducing bushes, Pipe connectors

About Bosal

BOSAL is a leading manufacturer in the fields of mobility and energy, with 17 industrial sites, 12 distribution centers, 7 R&D centers and 2,500 employees around the world.

BOSAL's mission is to contribute to a cleaner world by consistently innovating in mobility and energy. At the same time, we pride ourselves in offering tailored solutions to meet the challenges of future generations in line with our values.

Reducing bushes

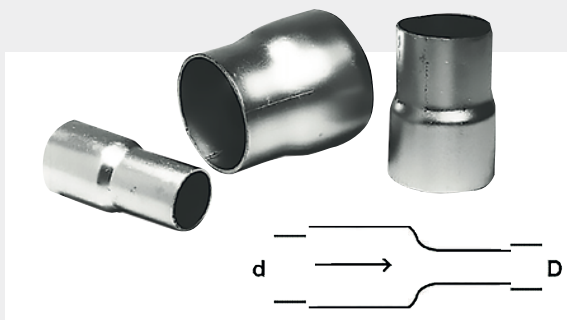

Aluminised

Bosal n°	Inside diameter (mm)	Outside diameter (mm)	Length (mm)
264-728	28	25	80
264-735	35	32	80
264-738	38	35	80
264-741	41	38	80
264-745	45	42	80
264-748	48	45	80
264-750	50	48	80
264-753	54	50	80
264-757	57	54	80
264-760	60	57	80
264-765	65	60	80
264-770	70	65	80
264-775	76	70	80

Pipe connectors

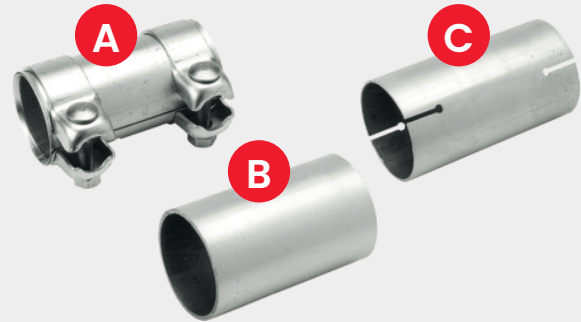

Bosal n°	Model	Inside diameter (mm)	Length (mm)
265-135	A	38	95
265-131	C	42	145
265-191	A	67	80
265-810	A	40	80
265-125	A	43	125
265-895	A	45	80
265-619	A	45	120
265-813	C	45	145
265-169	B	42	160
265-129	A	46	95
265-833	A	50	80
265-687	A	50,5	95
265-459	A	50,5	125
265-505	A	53	95
265-621	A	55	120
265-827	A	56	95
265-119	A	56	125
265-127	A	60,5	80
265-829	A	61	95
265-955	A	61	125
265-897	B	42,5	80
265-942	C	52	120
265-891	C	42	120
265-909	C	45	120
265-251	C	49	120
265-913	C	50	120
265-893	C	55	120
265-617	C	60	100
265-123	C	60	120

Insulator blocks

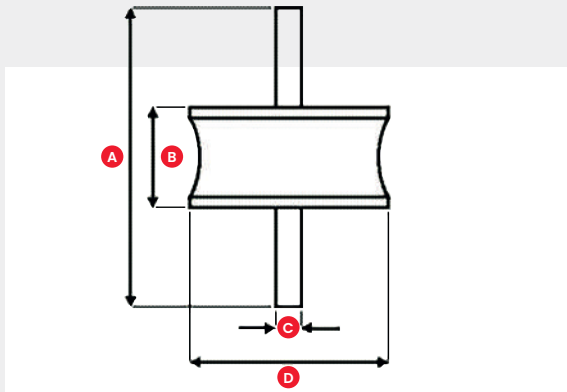

Bosal n°	A (mm)	B (mm)	C	D Diameter (mm)
255-015	43	15	m8	30
255-038	48	18	5/16" UNF	32
255-048	45	25	m6	20
255-049	35	15	m6	20
255-330*	65	28	m10	42
255-333*	65	28	m8	42
255-453	62	30	m6	20
255-458	60	20	5/16" UNF	32
255-473	70	30	m8	30
255-517	70	30	m8	40
255-627	51	25	m6	22
255-736	68	34	3/8" UNF	58



Round tubes for exhaust systems

Steel tubes

Bosal n°	Outside diameter (mm)	Length (m)	Material thickness (mm)
261-832	32	1,95	1,50
261-835	35	1,95	1,50
261-838	38	1,95	1,50
261-841	42	1,95	1,50
261-845	45	1,95	1,50
261-848	48	1,95	1,50
261-850	50	1,95	1,50
261-854	54	1,95	1,50
261-857	57	1,95	1,50
261-860	60	1,95	2,00
261-863	65	1,95	2,00
261-870	70	1,95	2,00
261-875	76	1,95	2,00
261-880	80	1,95	2,00
261-889	90	1,95	2,00
261-900	102	1,95	2,00
261-950	127	1,95	2,00

Exhaust cement



258-501
258-502
258-503
258-504
258-002



258-011

Bosal n°	Packing quantity	Language on packaging
258-501	2 x 570 gr.	english, german, dutch, polish
258-502	5 x 190 gr.	english, german, dutch, french
258-503	10 x 60 gr.	dutch, french
258-504	10 x 60 gr.	english, german
258-011	1 x 250 gr.	english, german, polish
258-002	60 x 190 gr.	hungarian, romanian

Aluminised pipe extensions



Bosal n°	Material thickness (mm)	Inside diameter (mm)	Outside diameter (mm)	Length (mm)
264-435	1,5	35	35	400
264-438	1,5	38	38	400
264-441	1,5	42	42	400
264-445	1,5	45	45	400
264-448	1,5	48	48	400
264-450	1,5	50	50	400

Galvanised flexible tubes



Special quality for exhaust systems
(copper packed interlock)

Bosal n°	Inside diameter (mm)	Length (m)
260-025	25	2,00
260-028	28	2,00
260-032	32	2,00
260-035	35	2,00
260-038	38	2,00
260-041	41	2,00
260-045	45	2,00
260-048	48	2,00
260-050	50	2,00
260-053	53	2,00
260-057	57	2,00
260-060	60	2,00
260-065	65	2,00
260-070	70	2,00
260-075	75	2,00
260-080	79	2,00
260-090	89	2,00
260-100	102	2,00

Universal oxygen sensors



Bosal n°	Description
000-091	Universal oxygen sensor zirconia 1 wire
000-092	Universal oxygen sensor zirconia 2 wires
000-093	Universal oxygen sensor zirconia 3 wires
000-095	Universal oxygen sensor zirconia 4 wires

Universal catalytic converters for petrol engines



099-948

099-949

Without eu homologation

Please check your local legislation if the application of universal catalytic converters is allowed

Bosal n°	Shape	To be used for Euro 2 vehicles with engines up to	Length (mm)	Width (mm)	Height (mm)	Inlet / Outlet inside diameter (mm)	Inlet / Outlet outside diameter (mm)
099-948	Oval	2.0 L	333	165	100	47	51,3
099-949	Round	2.0 L	333	120	115	47	51,3

Universal silencer line

Dimensions in mm / without eu homologation

Bosal n°	Diagram
248-004	
248-169	
248-009	
248-155	
248-153	
248-010	
248-016	
248-163	
248-013	
248-059	

Bosal n°	Diagram
248-002	
248-061	
248-062	
248-063	
248-160	
248-158	
248-159	
248-184	
248-012	
248-014	
248-011	
248-185	

Hanging hook



Bosal n°	Packing quantity
268-043	100

PSA flanges

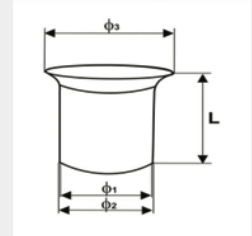
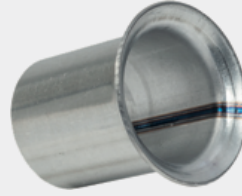

Bosal n°	Inside diameter (mm) Ø1	Outside diameter (mm) Ø2	Outside diameter (mm) Ø3	Length (mm)
263-001	37	40	56	65,5
263-003	41	45	62,6	65
263-005	46	50	66,5	65,5
263-007	50	54	71	66
263-009	56	60	80	64
263-011	61	65	80	64

Magnetic label

Bosal n°	Size (mm)	Packing quantity
268-037	95 x 25	100
268-045	95 x 30	100

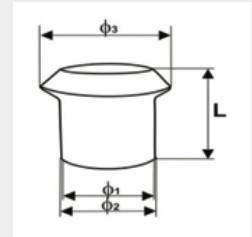

Bosal n°	Inside diameter (mm) Ø1	Outside diameter (mm) Ø2	Outside diameter (mm) Ø3	Length (mm)
263-002	37	40	56,3	58,3
263-004	41	45	60,7	58,2
263-006	46	50	67	59
263-008	50	54	70	59
263-010	56	60	77	59
263-012	61	65	77	59

Universal suspension brackets



Bosal n°	Length (mm)
252-875	360



Bosal n°	Kit
263-013	Kit 40 mm -> 263-001 + 263-002 + 254-627
263-014	Kit 45 mm -> 263-003 + 263-004 + 254-920
263-015	Kit 50 mm -> 263-005 + 263-006 + 254-930
263-016	Kit 54 mm -> 263-007 + 263-008 + 254-930
263-017	Kit 60 mm -> 263-009 + 263-010 + 254-940
263-018	Kit 65 mm -> 263-011 + 263-012 + 254-940

EOLYS® DPF additives range

Designated for the engines equipped with DPF PSA technology, EOLYS® additives reduce the particles combustion temperature facilitating DPF regeneration. Each additives generation is designed for a dedicated engine type.



Bosal n°	Description	Content (L)	OE number
258-975	EOLYS® DPX42	1	973665
258-972	EOLYS® DPX42	4,5	997995
258-976	EOLYS® 176	1	1623961380
258-971	EOLYS® 176	3	1623961480
258-977	EOLYS® POWERFLEX	1	9736A0
258-978	EOLYS® POWERFLEX	3	9736A1
258-968	EOLYS® EXTEND	1	1623961580
258-969	EOLYS® EXTEND	3	1623961680

Each kit is composed of:
1 additive bottle, 1 empty bottle to collect the residues and recycling, 1 filling kit

Regeflex



Diesel particulate filter cleaner
(suitable for all diesel vehicles fitted with a dpf)

- Facilitates soot combustion
- restores engine power and improves fuel economy
- cleans diesel injection system
- cleans turbocharger and egr valve
- a unique patented technology

Bosal n°	Content (L)
258-979	1

Did you know?

Did you know that Bosal will celebrate its centenary in 2023?

In 1923, Karel Bos opened the first workshop in Alkmaar in the Netherlands, hence the name of the company: (Karel) Bos + Al(kmaar). Since then, BOSAL has grown to become one of the leading innovators of the automotive and energy industries, contributing to shaping a cleaner future at every step.



bosal :aftermarket

innovation as business driver

Bosal aftermarket
www.bosal.com
www.catalogue.bosal.com
am.info@bosal.com